

BERKELEY



ERIC KUSTER®  
METROPOLITAN LUXURY

# BERKELEY

## PRODUCT INFORMATION - CONNECTION CORNER

The Berkeley product line can be tailored to fit your precise size requirements.

A digital representation of your furniture combination can be created upon request.

Frame	Solid beechwood
Frame padding	Cold foam 90561
Seat cushion(s)	Nosag feathers with Pantera 50160 (cold foam)
Back cushion(s)	Pantera 50 (covered with dacron)

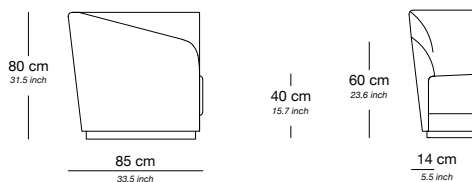

### Connection Corner

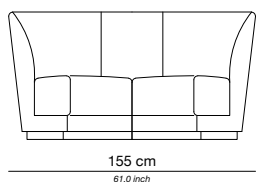

Base / Feet / Finish	Fabric (m)	Leather (m <sup>2</sup> )	Note
Solid beechwood dark brown	6,5	13	-
Solid beechwood black	6,5	13	-

# BERKELEY

## PRODUCT INFORMATION - CORNER SOFA

The Berkeley product line can be tailored to fit your precise size requirements.

A digital representation of your furniture combination can be created upon request.

Frame	Solid beechwood
Frame padding	Cold foam 90561
Seat cushion(s)	Nosag feathers with Pantera 50160 (cold foam)
Back cushion(s)	Pantera 50 (covered with dacron)

Corner Sofa

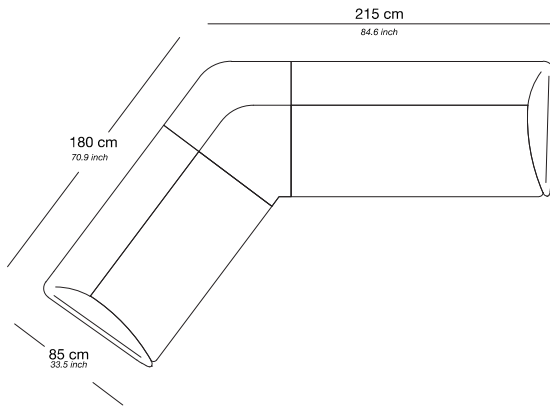

Base / Feet / Finish	Fabric (m)	Leather (m <sup>2</sup> )	Note
Solid beechwood dark brown	16	32	-
Solid beechwood black	16	32	-

# BERKELEY

## PRODUCT INFORMATION - ELEMENTS

The Berkeley product line can be tailored to fit your precise size requirements.

A digital representation of your furniture combination can be created upon request.

Frame	Solid beechwood
Frame padding	Cold foam 90561
Seat cushion(s)	Nosag feathers with Pantera 50160 (cold foam)
Back cushion(s)	Pantera 50 (covered with dacron)

Sofa side view

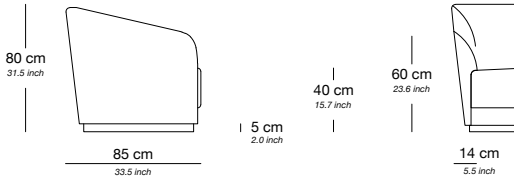

Base / Feet / Finish	Fabric (m)	Leather (m <sup>2</sup> )	Note
Solid beechwood dark brown	4	8	-
Solid beechwood black	4	8	-

Element 115

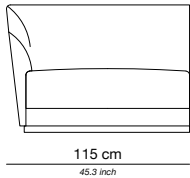

Base / Feet / Finish	Fabric (m)	Leather (m <sup>2</sup> )	Note
Solid beechwood dark brown	6	12	-
Solid beechwood black	6	12	-

Element 130

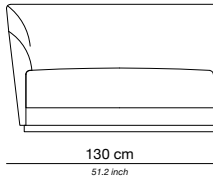

Base / Feet / Finish	Fabric (m)	Leather (m <sup>2</sup> )	Note
Solid beechwood dark brown	6	12	-
Solid beechwood black	6	12	-

Element 140

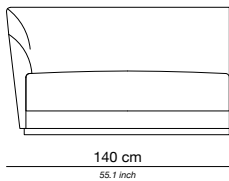

Base / Feet / Finish	Fabric (m)	Leather (m <sup>2</sup> )	Note
Solid beechwood dark brown	7	14	-
Solid beechwood black	7	14	-

Element 165

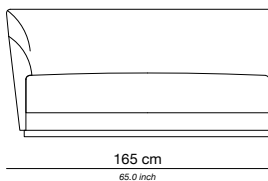

Base / Feet / Finish	Fabric (m)	Leather (m <sup>2</sup> )	Note
Solid beechwood dark brown	8	16	-
Solid beechwood black	8	16	-

BERKELEY



ERIC KUSTER®  
METROPOLITAN LUXURY

# BERKELEY

## PRODUCT INFORMATION - ARMCHAIR

Frame	Solid beechwood
Frame padding	Cold foam 90561
Seat cushion(s)	Nosag feathers with Pantera 50160 (cold foam)
Back cushion(s)	Pantera 50 (covered with dacron)

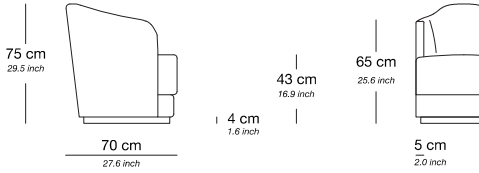

### Dining Armchair

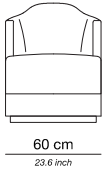

Base / Feet / Finish	Fabric (m)	Leather (m <sup>2</sup> )	Note
Solid beechwood dark brown	3,5	7	-
Solid beechwood black	3,5	7	-

# BERKELEY

## PRODUCT INFORMATION - LOUNGE CHAIR

Frame	Solid beechwood
Frame padding	Cold foam 90561
Seat cushion(s)	Nosag feathers with Pantera 50160 (cold foam)
Back cushion(s)	Pantera 50 (covered with dacron)

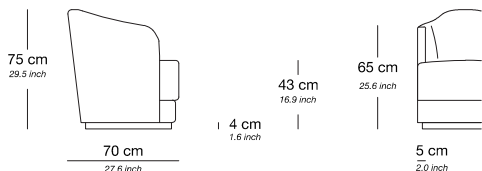

Lounge Chair

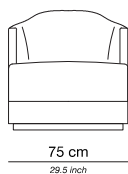

Base / Feet / Finish	Fabric (m)	Leather (m <sup>2</sup> )	Note
Solid beechwood dark brown	4,2	8,4	-
Solid beechwood black	4,2	8,4	-

# BERKELEY

## PRODUCT INFORMATION - LOVESEAT

Frame	Solid beechwood
Frame padding	Cold foam 90561
Seat cushion(s)	Nosag feathers with Pantera 50160 (cold foam)
Back cushion(s)	Pantera 50 (covered with dacron)

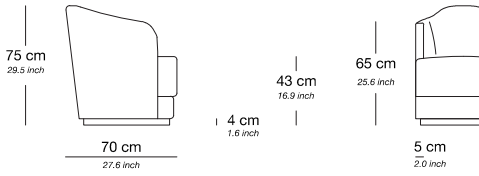

### Loveseat

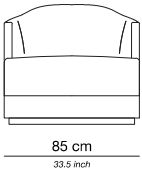

Base / Feet / Finish	Fabric (m)	Leather (m <sup>2</sup> )	Note
Solid beechwood dark brown	5	10	-
Solid beechwood black	5	10	-



