



GABRIEL SCOTT

EST. 2012

MYRIAD

Vertical Chandelier 7

in Satin Copper &
Alabaster White

The Myriad series is inspired by nature's bioluminescent organisms, this modular series is made up of the brand's signature doubleblown glass and satin metallic hardware. Its articulated stems carry the soft lit pivoting heads to create a delicate, asymmetric and ever changing silhouette.

These fine, jewel like fixtures are offered in assorted arrangements and available in various metal and glass finishes.

All Gabriel Scott pieces are handmade in Canada.



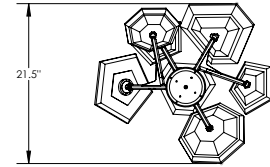
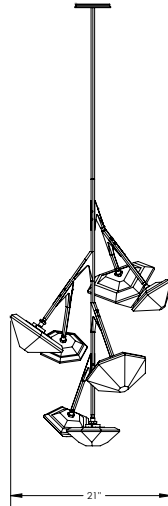
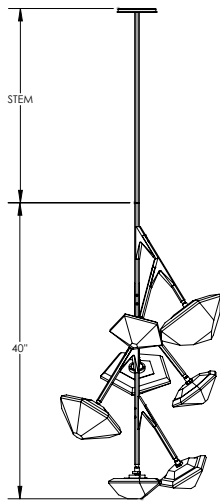

SPECIFICATIONS

Standard Finishes:

Blown Glass: Alabaster White

Metal: Blackened Steel, Satin Nickel, Satin Brass, Satin Copper or Satin Bronze

Specifications:

Dimensions: 21 x 21.5" x 40" H + Stem

53 cm x 55 x 102 cm H + Stem

Weight: 75 lbs / 34 kg

Light Source: 12V 6 Watt LED (included)

LED Drivers: E60L12DC-KO - 110V
UVC1250TD - 220V

Standard Lead time: 12 - 14 weeks

Stems & Canopies:

Standard Stem Lengths: 6", 12", 18" or 24"

15 cm, 31 cm, 46 cm or 61 cm

Additional Stem Lengths: 30", 36", 42" or 48"

76 cm, 91 cm, 107 cm or 122 cm
(up-charge applies)

Standard Canopy: 5" x 0.5" / 12 cm x 1.3cm

Deep Canopy: Dimensions on request.

Custom finishes available upon inquiry.

Made and assembled in Canada. Item is UL & CE listed.

STANDARD FINISHES

Blown Glass:



Alabaster White

Metal:

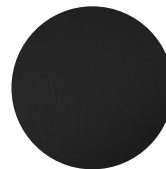

Blackened Steel



Satin Nickel



Satin Brass



Satin Copper



Satin Bronze

LED DRIVER

E60L12DC-KO - 110V

Magnitude's E60L12DC-KO dimmable voltage LED driver is class 2 rated and designed to operate with any standard MLV/ Incandescent TRIAC (Leading edge) dimmer switch. Encased in a low profile aluminum enclosure that includes 2 knock-outs to enable easy installation makes it the perfect choice for under cabinet lights, tape lights and various LED fixtures installations. Our electrical specification includes Auto Reset, over current and short circuit protection. Efficiency of 90% and higher allows the driver to operate at low temperatures.

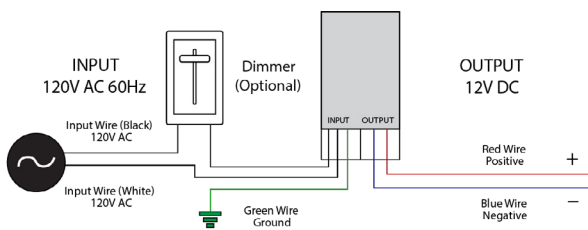
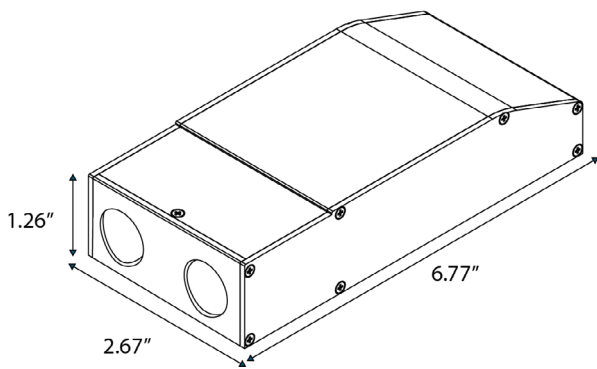

Features:

- Dimmable with any standard MLV/Incandescent TRI-AC- (Leading edge) dimmer switch.
- Super compact ALUMINUM CASE.
- Class 2
- UL 8750
- IP67 - Withstands wet and salty conditions.
- Nema 3R - Outdoor Use
- Auto-Reset Protection for short circuits & over-voltage.
- FCC 15 part 2
- 12V DC True RMS

Specifications:

Max Load	60W
Input Voltage	120V AC
Input Current at Max Load	0.61 A
Output Voltage	12V DC
Output Current at Max load	5.26 A
Power Factor	0.95
Efficiency	> 90 %
Operating Temp.	-20c - 70c (-4F -158F)
Short Circuit Protection	Yes
Overcurrent Protection	Yes
Over Temperature	Yes
Open Circuit Protections	Yes
Input Wires (White / Black)	14 AWG
Output Wires (Red / Black)	18 AWG
Weight	481g
Dimensions (inches)	6.77" x 2.67" x 1.26"
Dimensions (cm)	17.2cm x 6.8cm x 3.2cm

LED DRIVER

UVC1250TD - 220V

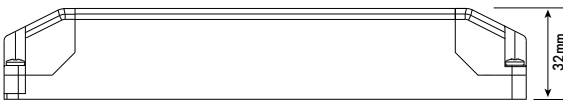
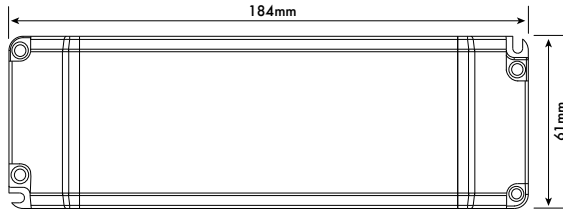

Features:

- Constant voltage output
- Fully isolated
- Short circuit, over current and over voltage protection up to 80% efficient.
- Fire resistant plastic cover
- Compatible with leading and trailing edge dimmers
- 20 - 100% Dimming Load and Dimming range
- Mains dimmable
- Screw terminals
- IP44 design for indoor use
- 2 years warranty

Specifications:

Part Code	UVC1250TD UVC2450TD
Voltage	220V - 240VAC
Frequency	50-60 Hz
Current	0.4A
Inrush Current	<2.5A
Power Factor	0.95
Load Voltage	12V
No Load Voltage	12V
Current	4.16A
Power	50W
Power Factor	>0.95
Efficiency (TYP)	>80%
Over Load	Auto-recovery
Short Circuit	Auto-recovery
Over Voltage	Auto-recovery
Operating Temperature	-20 ~ +50°C
Storage Temperature	-40 ~ +70°C
Relative Humidity	5 ~ 95%
Lifetime	50K hrs at TC max (85°C)
Connections	Screw terminal on I/P & O/P
Weight	200g
Dimensions (inches)	7.2" x 2.4" x 1.25"
Dimensions (cm)	18.4 cm x 6 cm x 3.2 cm